

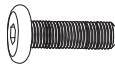







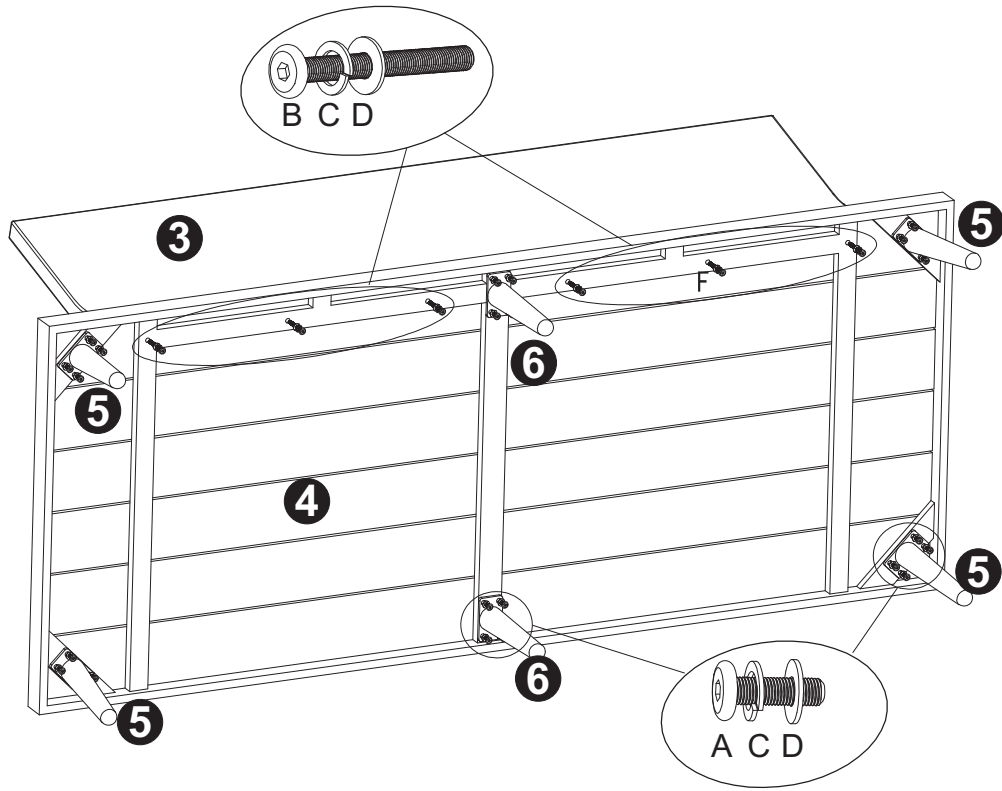

<p><b>A</b></p>  <p>M6x20 x24</p>	<p><b>B</b></p>  <p>M6x55 x6</p>	<p><b>C</b></p>  <p>M6 x30</p>	<p><b>D</b></p>  <p>M6 x30</p>	<p><b>E</b></p>  <p>M6 x1</p>
--	---	---	---	--

1



<b>A</b>  M6x20 x24	<b>B</b>  M6x55 x6	<b>C</b>  M6 x30	<b>D</b>  M6 x30	<b>E</b>  M6 x1
--	---	---	---	---

2

