

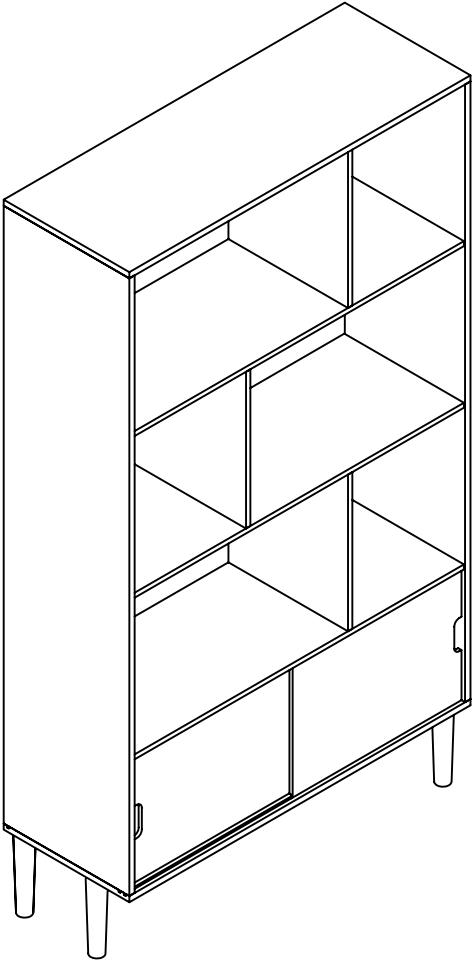

BLUSH

170 529





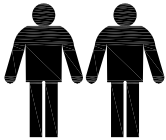
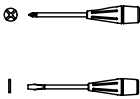
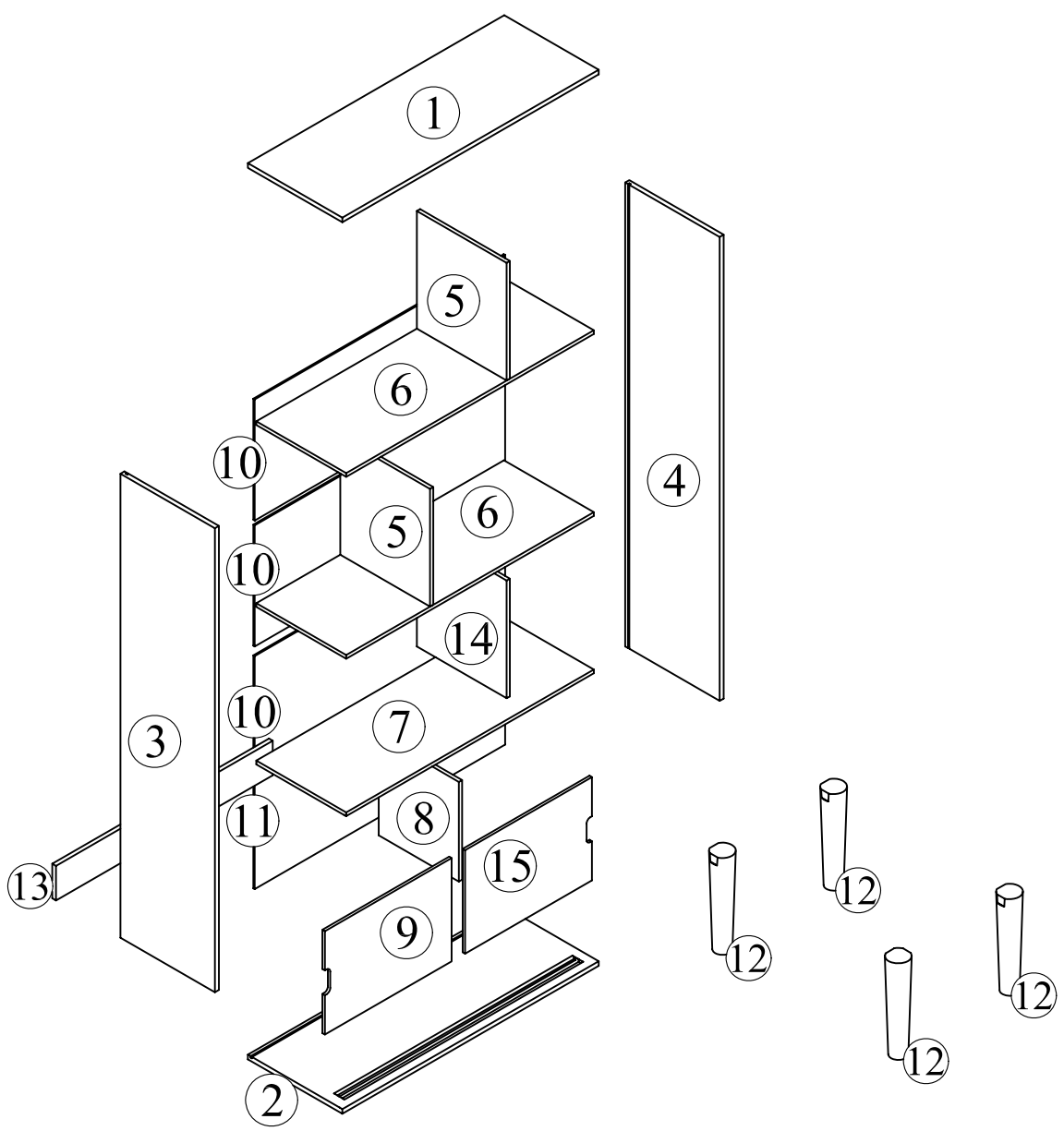
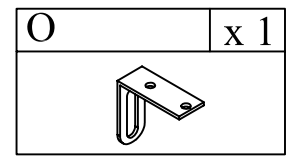
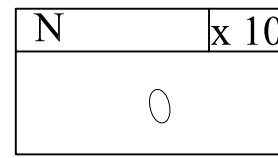
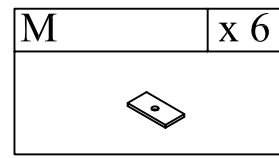
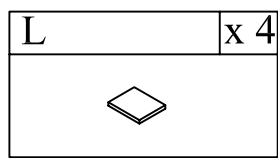
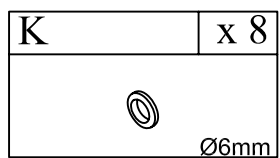
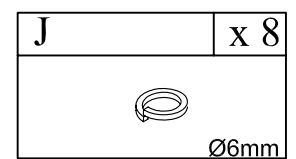
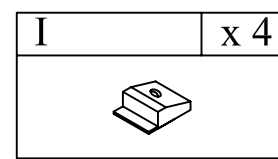
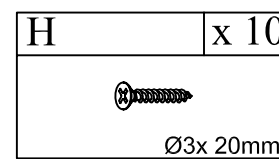
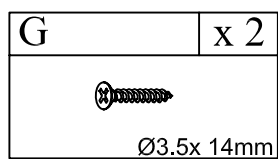
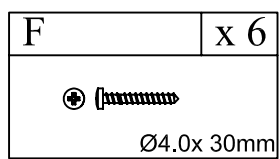
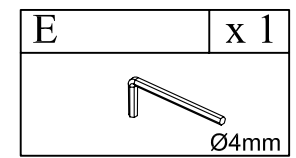
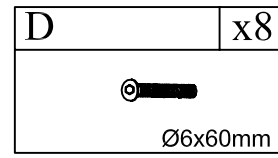
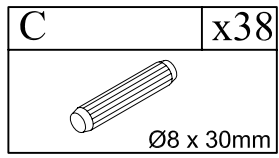
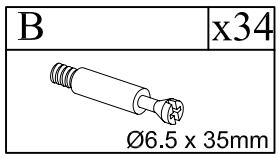
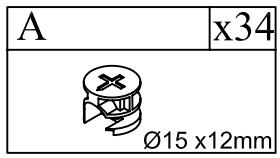

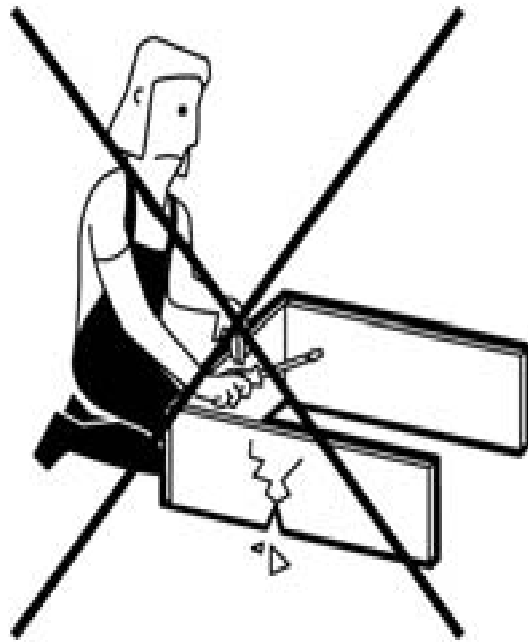
 <p>90MIN</p>		
--	---	---



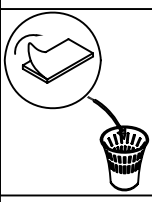
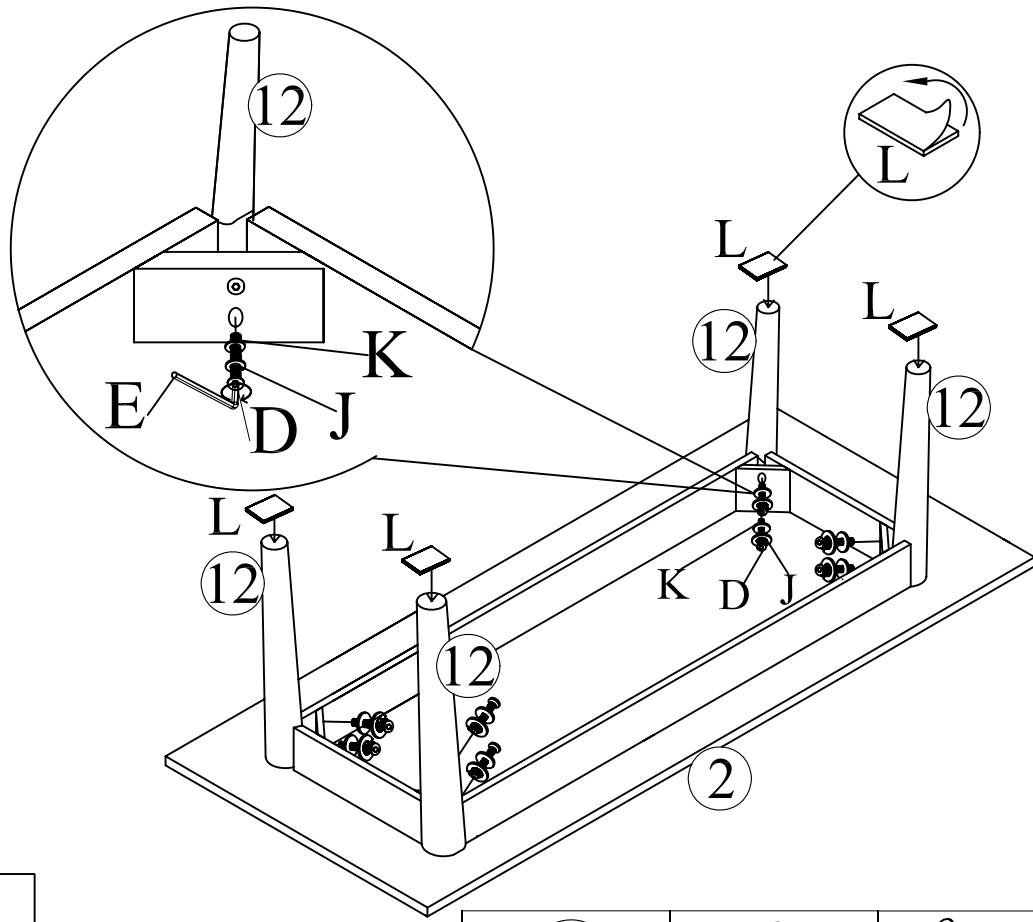

1

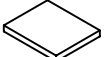

 J x 8 Ø6mm	 K x 8 Ø6mm	 D x 8 Ø6X60mm	 E x 1 Ø4mm
--	---	---	--

 L x 4
--

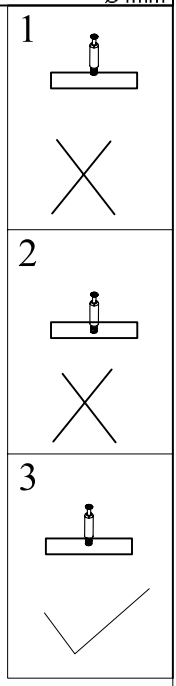
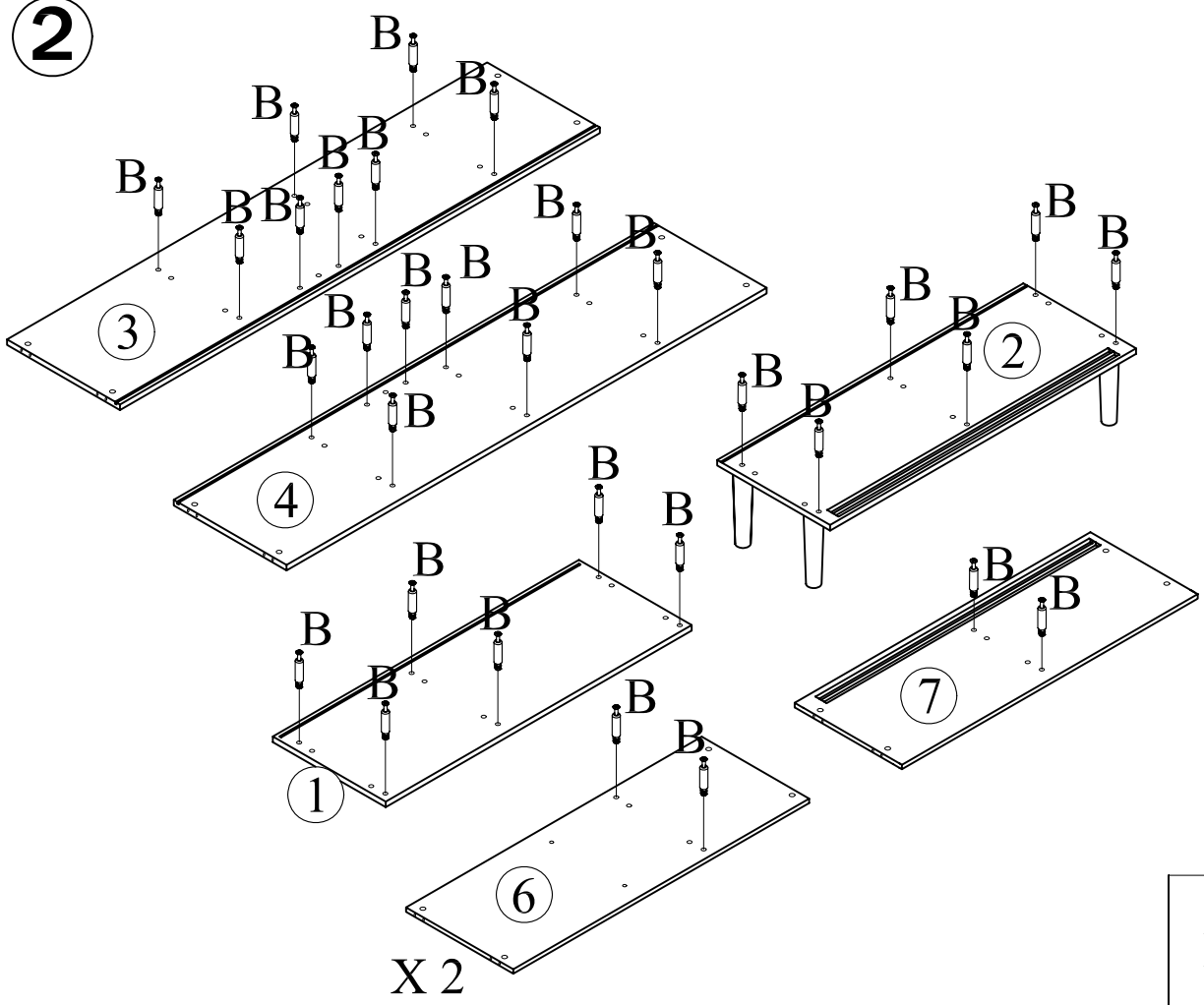

2

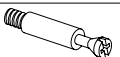

 B x 34 Ø6.5X35mm
--

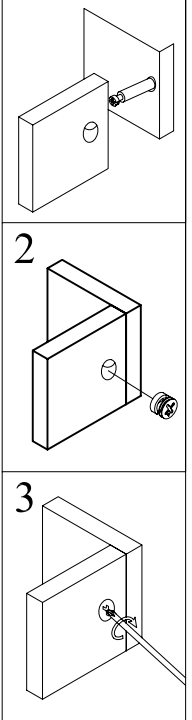
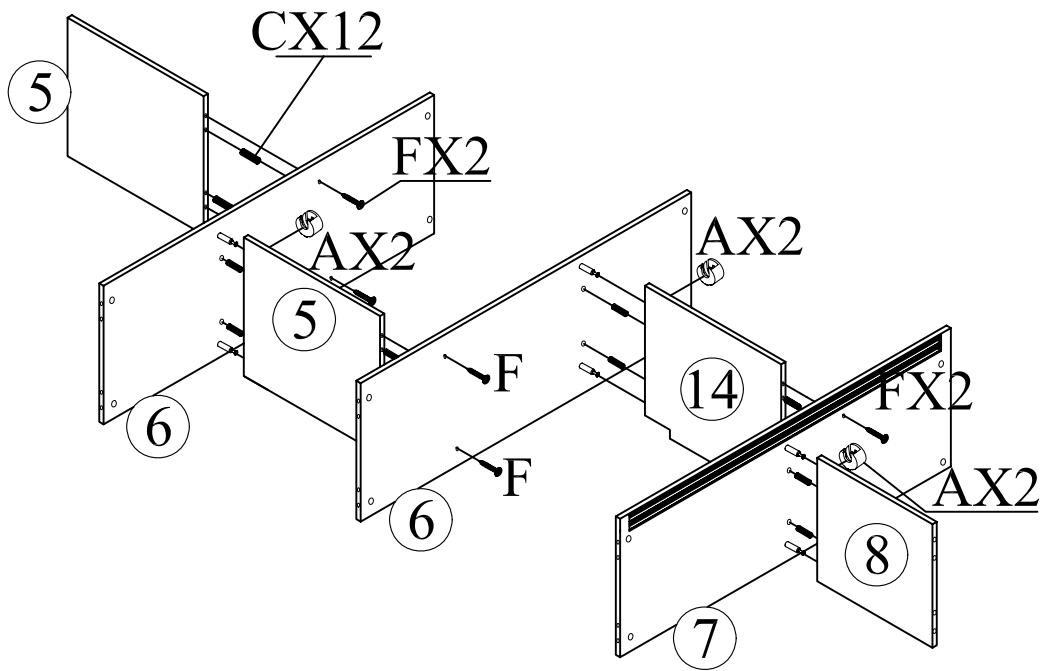

3



 A x 6 Ø15X12mm	 C x 12 Ø8X30mm	 F x 6 Ø4X30mm
--	--	---

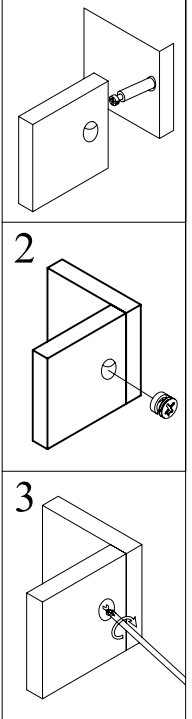
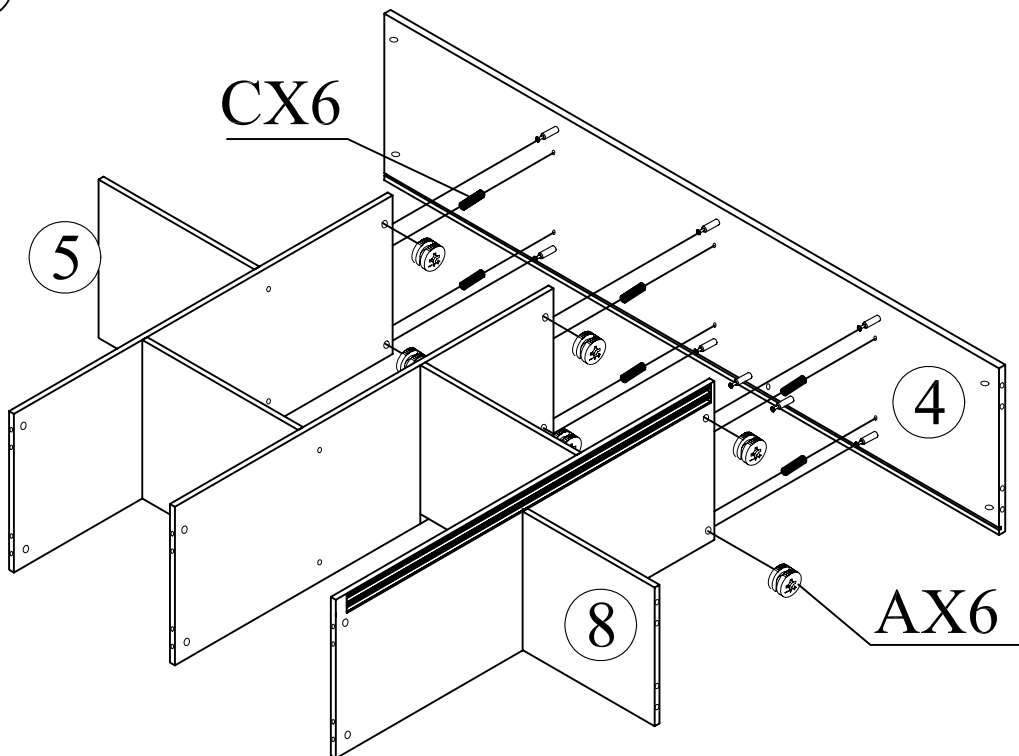

4

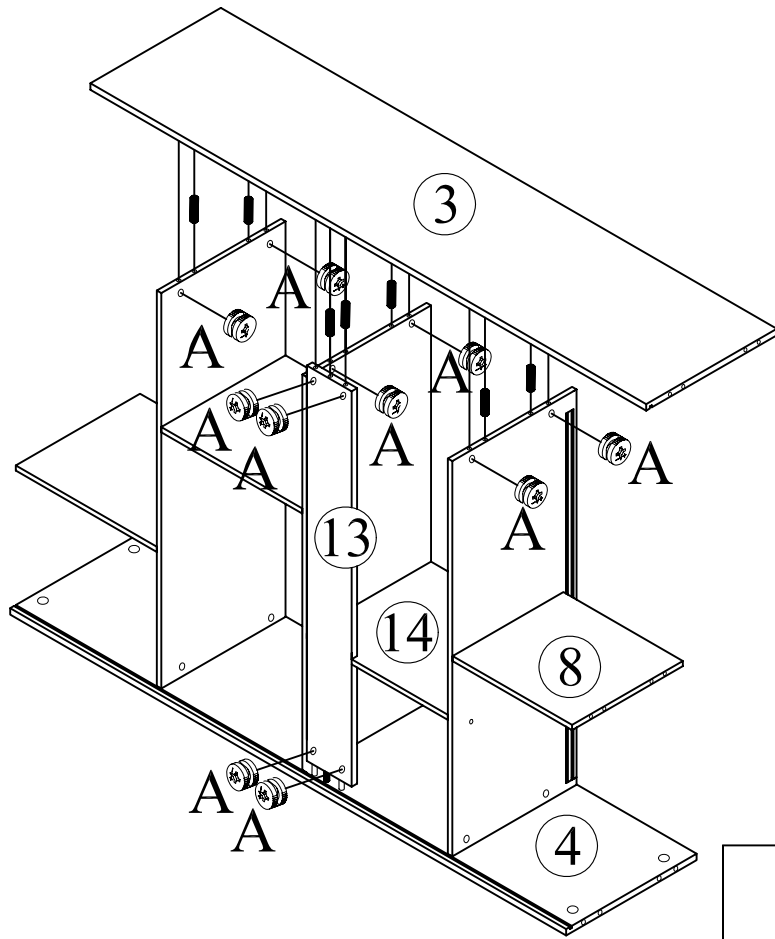

 C x 6 Ø8X30mm	 A x 6 Ø15X12mm
--	---

5

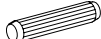

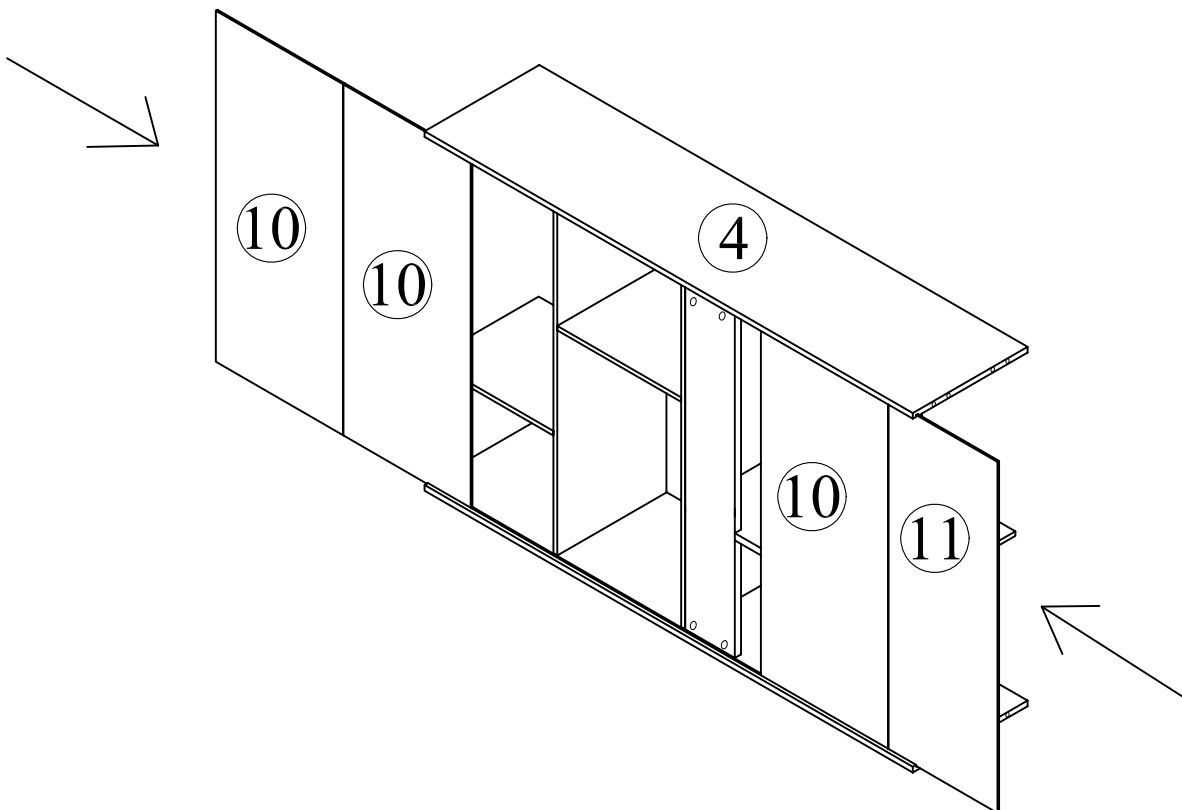

 C x 8 Ø8X30mm	 A x 10 Ø15X12mm
---	--

6



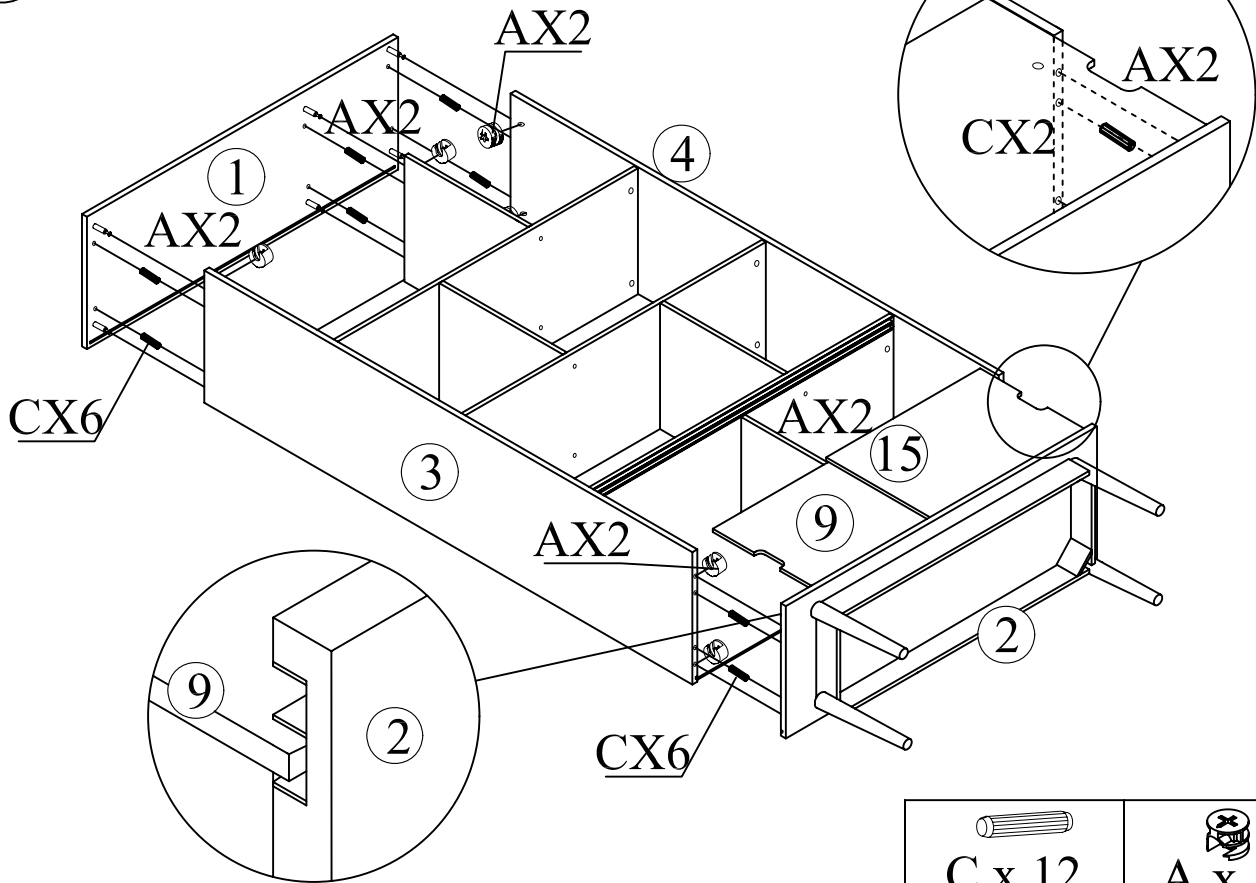



7

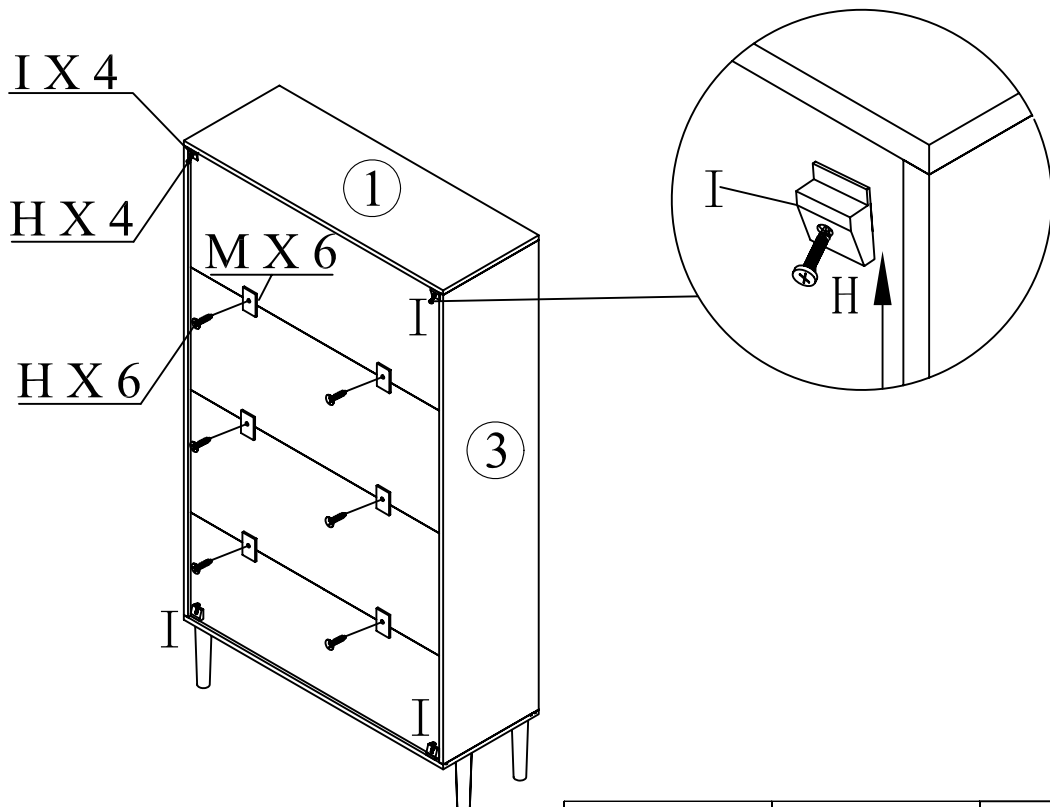

	
C x 12	A x 12
Ø8X30mm	Ø15X12mm

8



		
M x 6	I x 4	H x 10
		Ø3X20mm

9

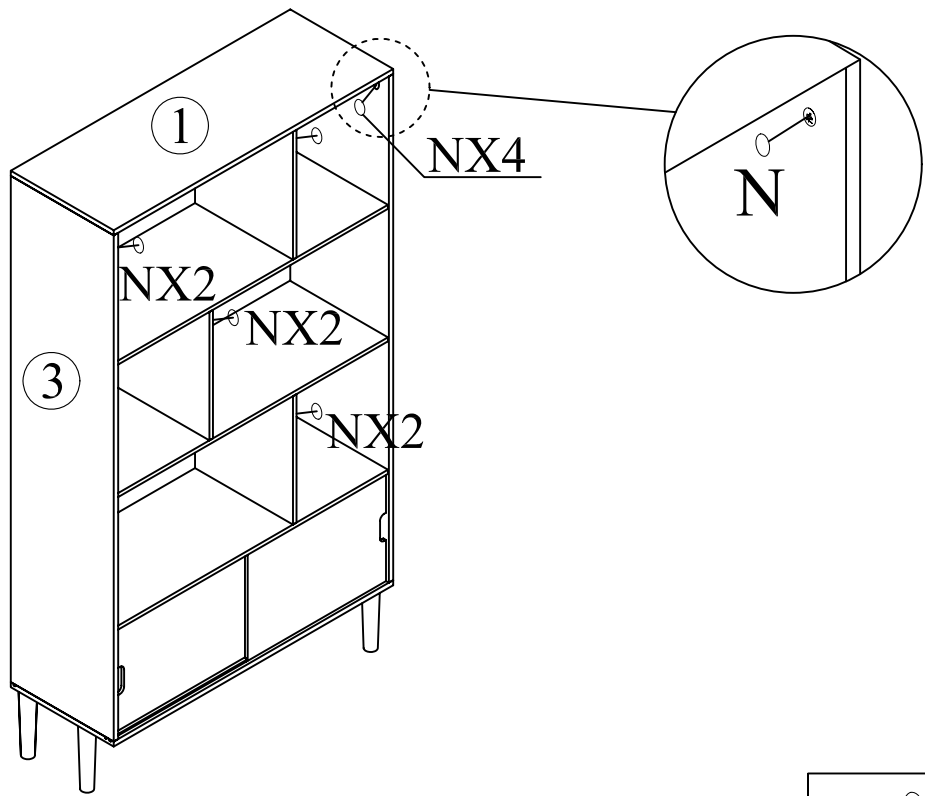

0
N x 10

10

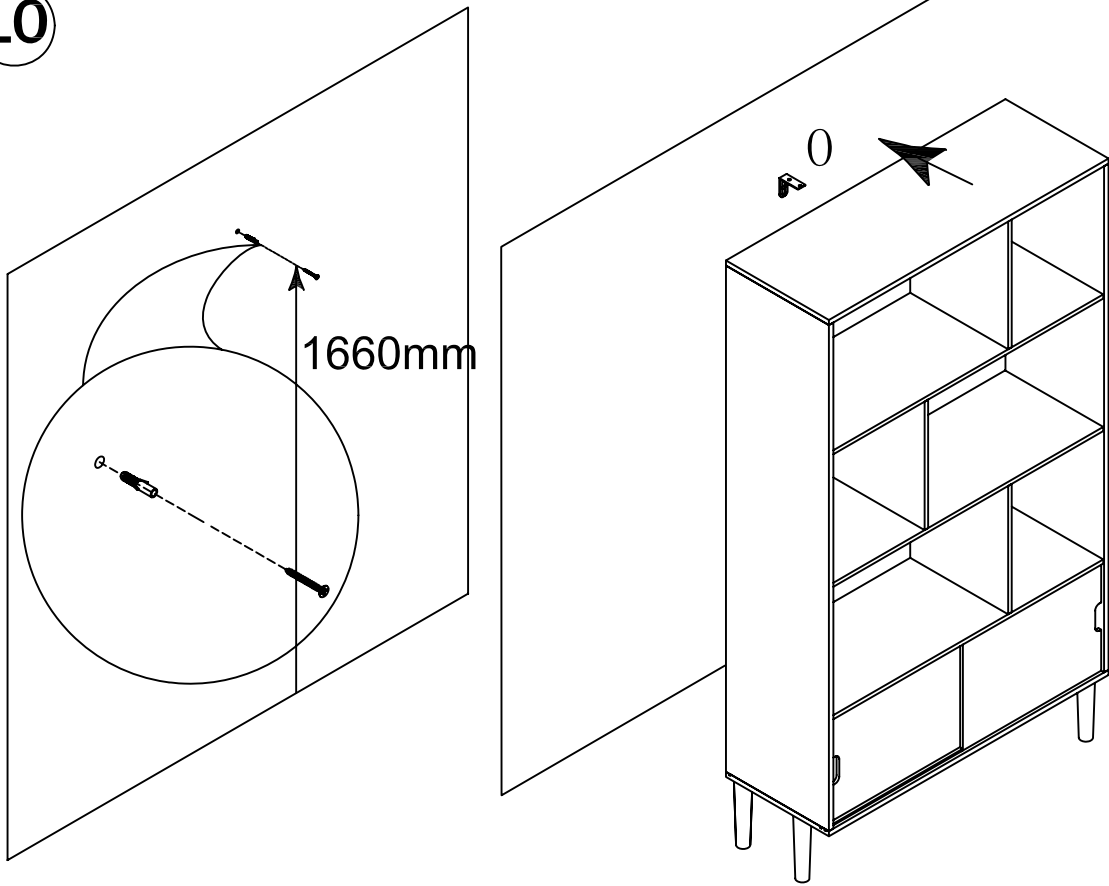

0 x 1

11

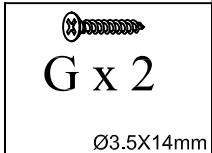
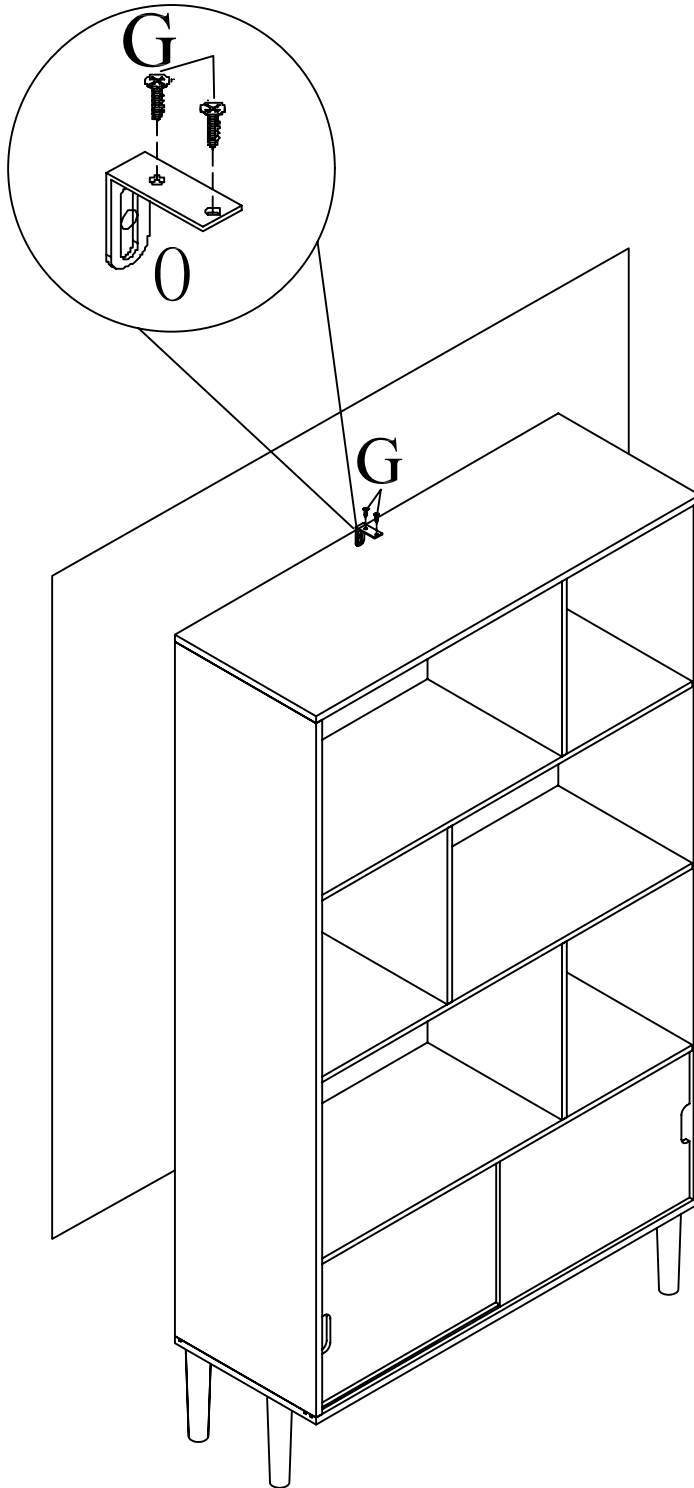

FR : Il existe une grande diversité de murs et de cloisons, c'est la raison pour laquelle nous ne pouvons vous fournir le type exact de fixation.
Il est nécessaire d'identifier le type de paroi à laquelle vous allez fixer ce produit afin de vous procurer les fixations appropriées

ENG : There are many different types of walls and partitions, which is why we cannot provide you with the exact type of mounting system.
You need to identify what type of wall you will be securing the product to and purchase the appropriate fasteners

PT : Existe uma grande diversidade de paredes e divisórias e é por este motivo que não podemos fornecer-lhe o tipo exato de fixação.
É necessário identificar o tipo de parede na qual pretende fixar este produto para obter as fixações adequadas

D : Es gibt viele unterschiedliche Wände und Zwischenwände, deshalb können wir Ihnen nicht die passende Befestigungsart liefern.
Sie müssen die Art von Wand, an der Sie dieses Produkt anbringen möchten, genau identifizieren, um sich die passenden Befestigungselemente zu beschaffen

IT : Data la grande varietà di pareti e tramezzi, non ci è possibile fornire il tipo esatto di attacco.
Per procurarsi gli attacchi appropriati, identificare il tipo di parete cui andrà fissato questo prodotto

DK : Der findes mange forskellige slags mure og vægge, og det er årsagen til, at vi ikke kan levere præcis den type monteringsudstyr, der er behov for.
Vi må vide, hvilken type væg dette produkt skal monteres på for at kunne levere det korrekte monteringsudstyr

SP :Existe una gran variedad de paredes y tabiques. Por este motivo, no podemos incluir el tipo exacto de fijación.
Es necesario identificar el tipo de pared a la que se fijará el producto antes de adquirir las fijaciones adecuadas

CAT : Hi ha una gran varietat parets i d'envans. Per això, no podem oferir-vos el tipus exacte de fixació.
Cal que identifiqueu el tipus de paret a què fixareu el producte abans d'adquirir les fixacions apropiades

NL : Er bestaan zeer veel soorten muren en wanden en dus is het voor ons onmogelijk om u de geschikte bevestiging te leveren.
U moet eerst bepalen op welk type wand u dit product gaat bevestigen zodat u de gepaste bevestigingsmiddelen kan aanschaffen

تنبيه:

تنبيه: يجب تثبيت هذا الأثاث في الحائط.

من الضروري التعرف على نوع الجدار الذي ستثبت عليه السرير في سبيل اقتناء التثبيتات المناسبة.