



 15 MIN	 2 PERSON	A  x4	B  x1	C  SIZE $\varnothing 12 \times 30$ MM. x16	D  x1
---	---	---	---	---	---

①



②

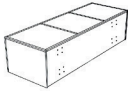

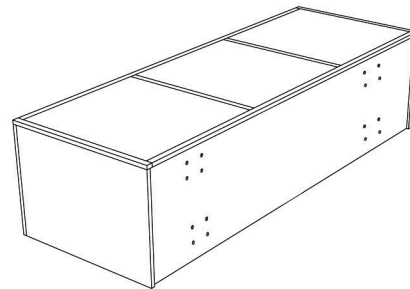
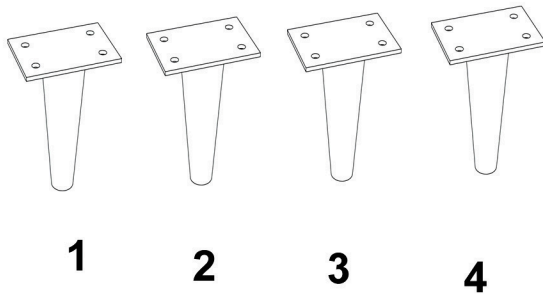
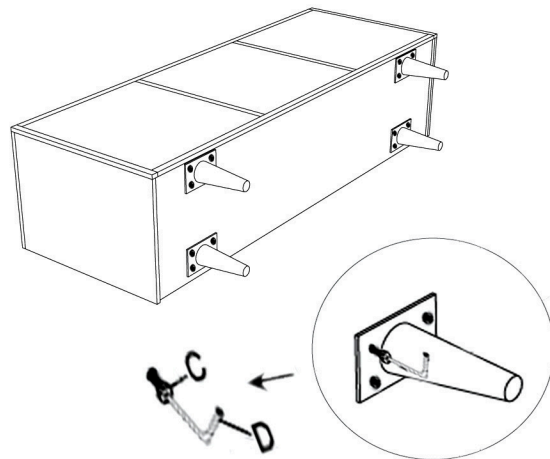
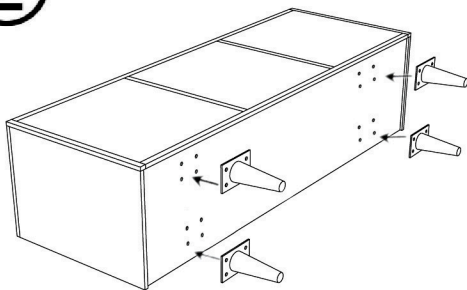
③

