

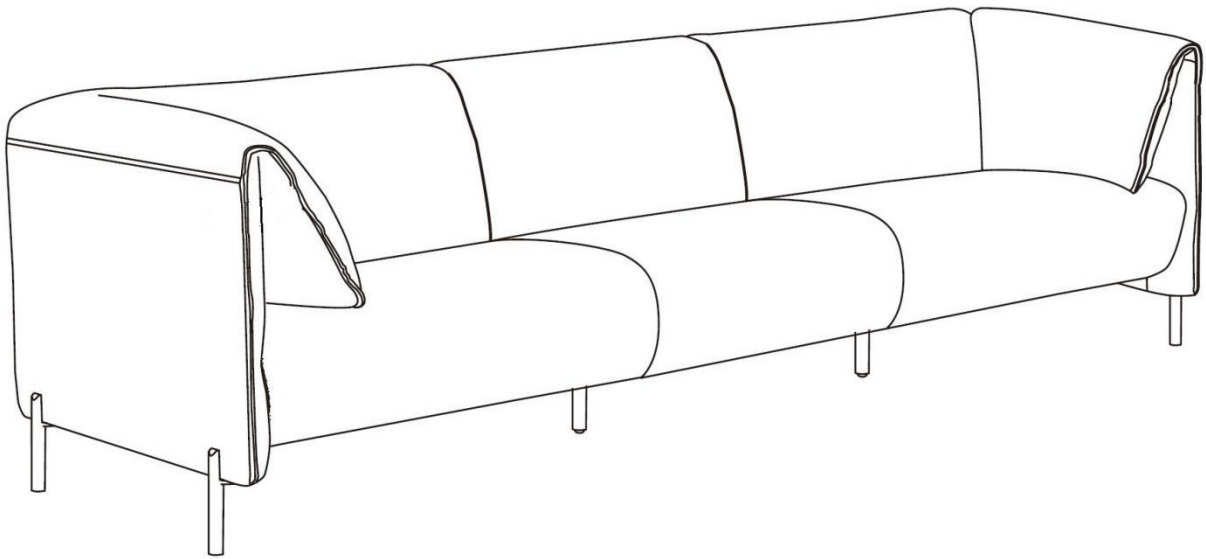







188550/188551/188552

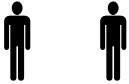
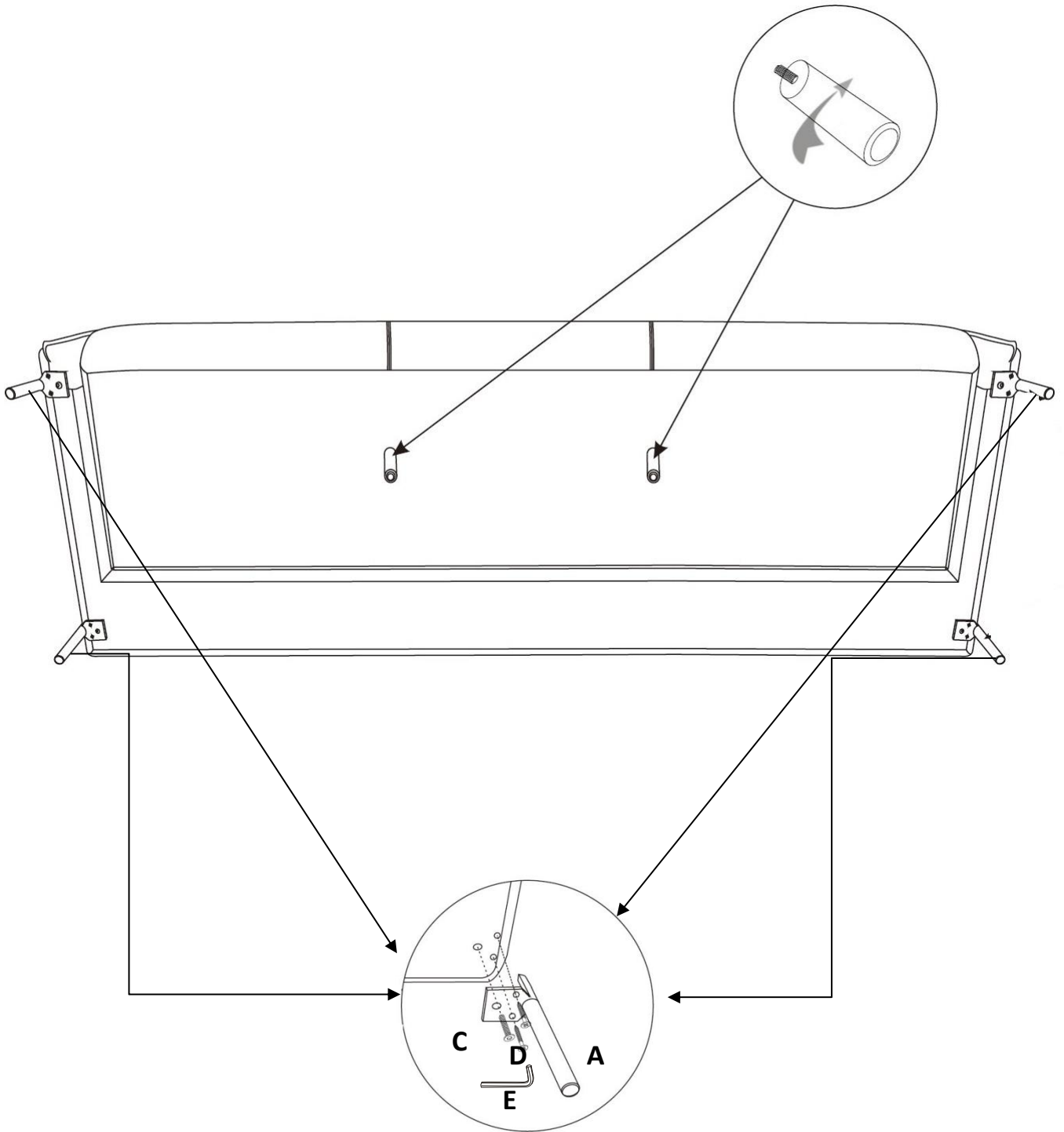

 10 MIN	
---	---

**B**



<p><b>A</b></p>  <p>(140MM)</p> <p>x 4</p>	<p><b>B</b></p>  <p>(Φ32MM x 170MM)</p> <p>x 2</p>	<p><b>C</b></p>  <p>(Φ10MM x 25MM)</p> <p>x 4</p>	<p><b>D</b></p>  <p>(Φ5MM x 50MM)</p> <p>x 8</p>	<p><b>E</b></p>  <p>x 1</p>
---	---	--	---	--