 20 MIN	
---	---

AX1

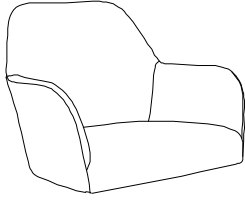

BX1



CX1



DX1









L

EX1





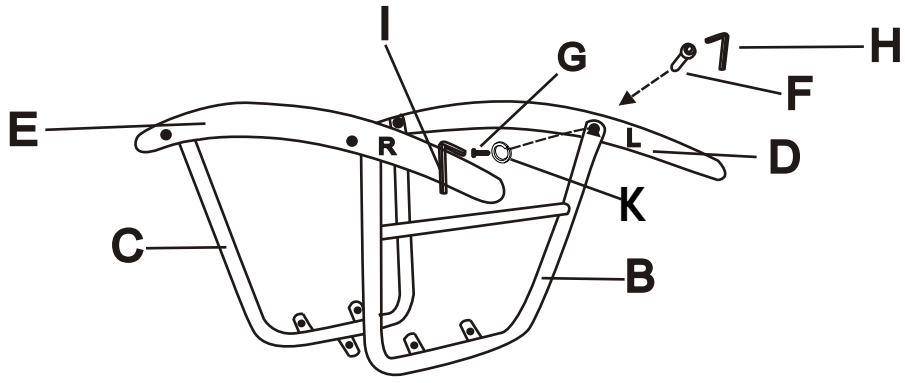

R

F  M5x15mm X4	G  M6x16mm X4	H  M5 X1	I  M6 X1	J  M6x20mm X5	K  M6 X4
--	--	---	---	--	---



①

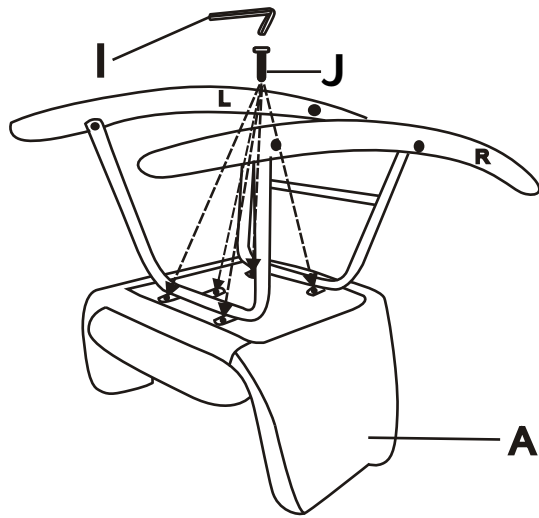

<p>F</p>  <p>M5x15mm</p> <p>X4</p>	<p>G</p>  <p>M6x16mm</p> <p>X4</p>	<p>H</p>  <p>M5</p> <p>X1</p>	<p>I</p>  <p>M6</p> <p>X1</p>	<p>K</p>  <p>M6</p> <p>X4</p>
--	--	---	---	---

②



<p>I</p>  <p>M6</p> <p>X1</p>	<p>J</p>  <p>M6x20mm</p> <p>X5</p>
---	--

3

