

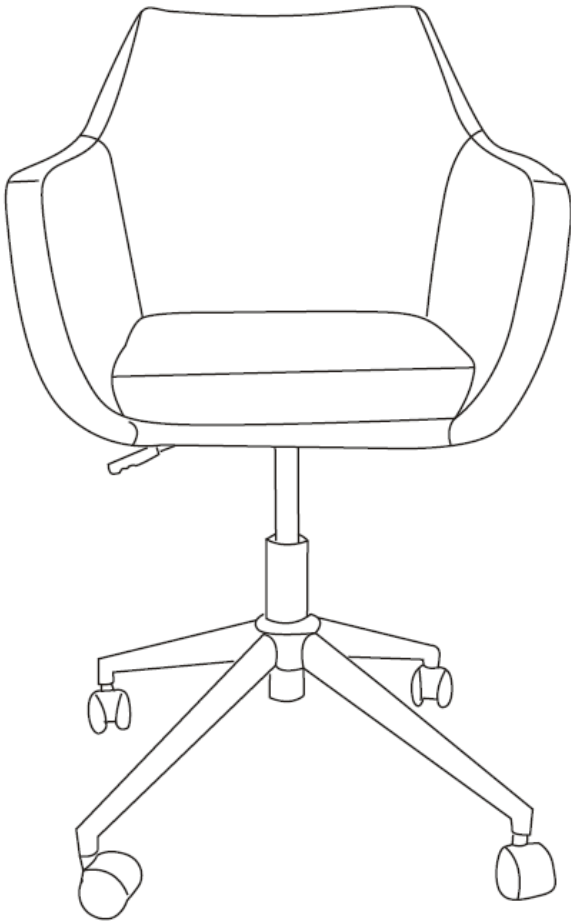



# DAVIS

165923/165924/  
186030









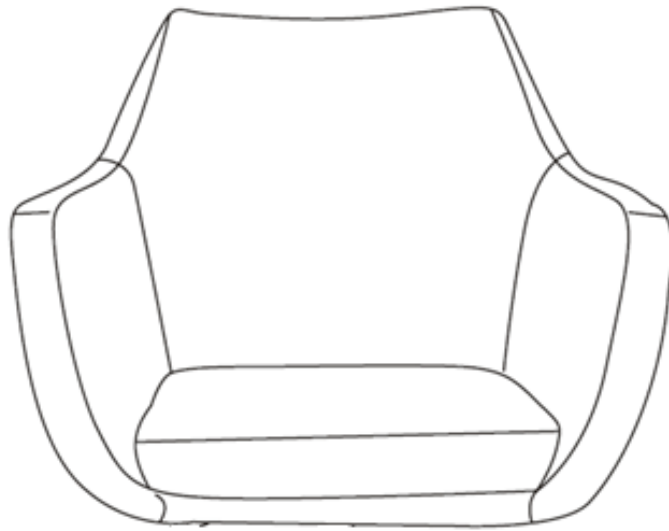



 20 MIN		
---	---	---



# AX1







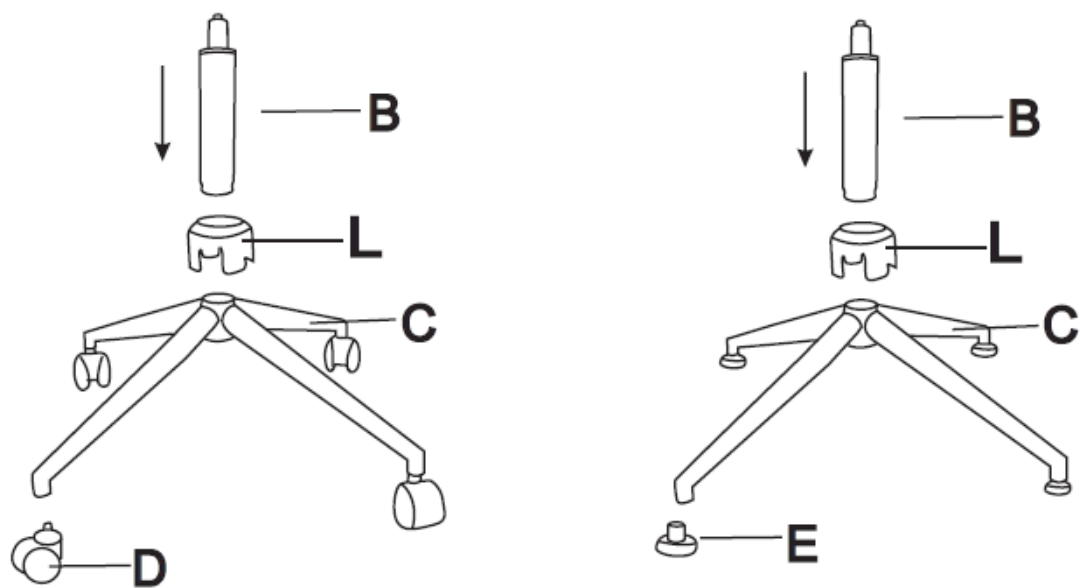

<b>B</b>  <b>X1</b>	<b>C</b>  <b>X1</b>	<b>D</b>  <b>X4</b>	<b>E</b>  <b>X4</b>	<b>F</b>  <b>X1</b>	<b>G</b>  <b>M6x20mm</b> <b>X2</b>
<b>H</b>  <b>M6x14mm</b> <b>X2</b>	<b>I</b>  <b>M6x18x1mm</b> <b>X4</b>	<b>J</b>  <b>M11x25x3mm</b> <b>X2</b>	<b>K</b>  <b>X1</b>	<b>L</b>  <b>X1</b>	

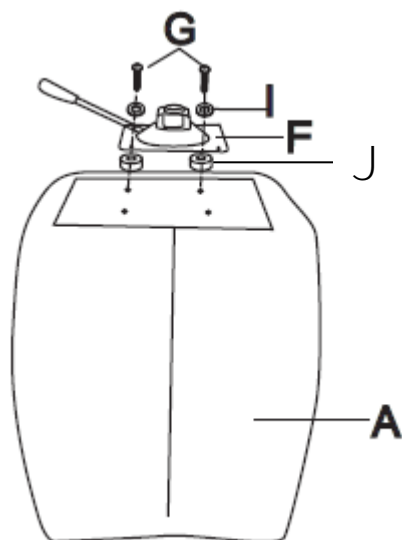
①





②



<p>F</p>  <p>X1</p>	<p>G</p>  <p>M6x20mm</p> <p>X2</p>	<p>I</p>  <p>M6x18x1mm</p> <p>X2</p>	<p>J</p>  <p>M11x25x3mm</p> <p>X2</p>	<p>K</p>  <p>X1</p>
--	---	---	--	--

③



<p>H</p>  <p>M6x14mm</p> <p>X2</p>	<p>I</p>  <p>M6x18x1mm</p> <p>X2</p>	<p>K</p>  <p>X1</p>
---	---	--

④

