

 15 MIN	
①  X 1	②  X 2
③  X 1	A  X 12
	B  X 1

1

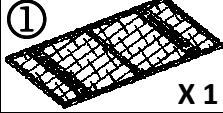

2

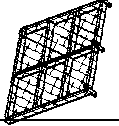
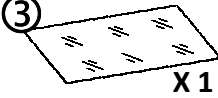
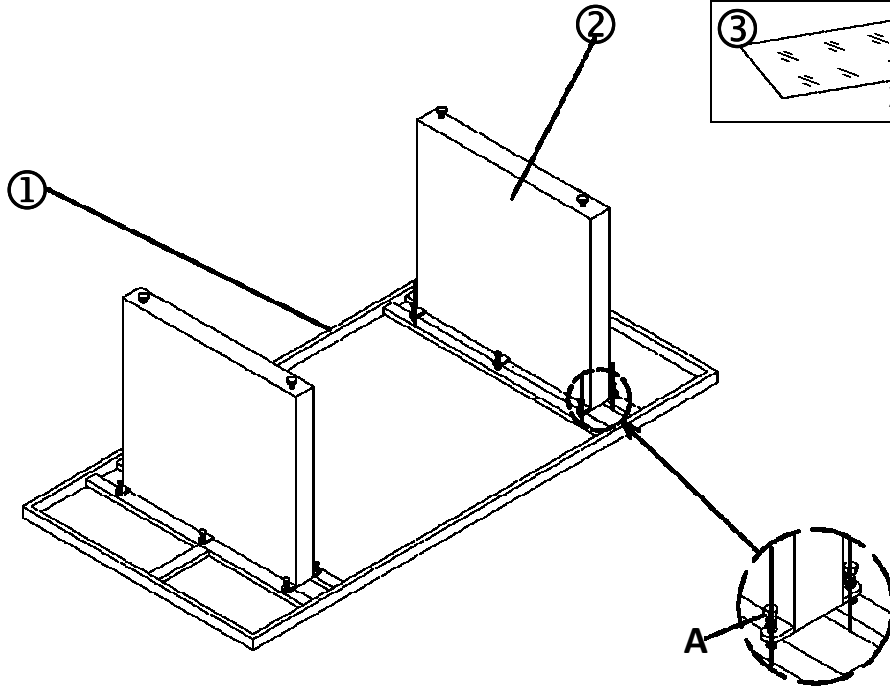